

Professional Audio Power Amplifier

user's manual

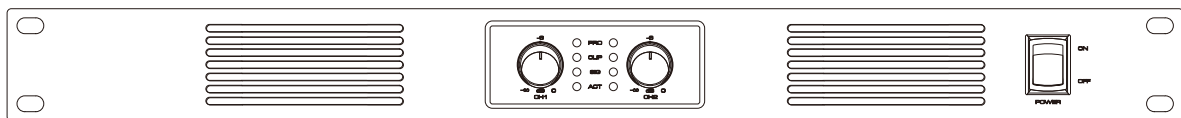

S-TRACK

Please read the user manual carefully before using this product
Please keep the manual properly for future reference

Preface

Welcome

Thank you for purchasing the company's professional audio products. Please read this user manual before use, it will give you the correct guidance, is essential for the normal operation of the equipment, and can prolong its life.

We have been working to develop high technology, high performance, competitive price, professional audio equipment. So far, we have different types, covering high, medium and low three levels, and can improve the quality of various occasions. In the research and development process, we have been trying to inject each product will be the soul of the high-tech, and create high quality equipment. We adhere to the ISO quality assurance system, with strict and necessary for professional supervision and every product is qualified, whether received perfect sales service.

We do it just for one purpose: to ensure clients benefit from our real high-tech, high-performance products and competitive price, and good after-sales service and technical support. Have been trying to return customers support for our products, to ensure that customers to buy our professional audio equipment is worth it.

Open box

Firstly check for any damage during transit on the machine. It is advisable to retain the packaging for a period of time to return the equipment needed. Confirm the voltage rating of equipment and region matching. (see the power supply on the rear panel)

Important security considerations

Our product safety management system throughout the product life cycle, from the stage of r&d, manufacturing and customer support. Efforts to ensure that security is "built-in" in the product, rather than the late "extension". We obtain professional product safety certification, in line with this kind of product of all conventional standards. But this internal hazardous voltage and power amplifier, require the user to read the note of this manual. If the product against dampness, drop, the internal parts loose, short circuit, will increase the risk of electric shock, disconnect the power supply, send the product to professional personnel for maintenance.

Support and service

During the use of this power amplifier, our dedicated customer service consultants, to provide one-stop service for you, will bother to provide you with free consulting services (service period) , service content, including hardware platform and software platform of the construction and operational guidance, and products used in the process of technology consulting, software upgrades and other services, to help customers quickly to complete the installation of the machine in the implementation process.

IMPORTANT SAFETY PRECAUTIONS AND SYMBOL DESCRIPTIONS

1. Read these rules.
2. Note all warnings.
3. Follow these rules.
4. Warning: To avoid fire or electric shock, do not expose the device to rain or humidity. Do not use this device near water.
5. If you need to clean the body, you can only wipe it with a dry cloth.
6. Do not block the vent, install according to the manufacturer's instructions.
7. Do not install near heat sources, such as radiators, heat regulators, stoves, or other equipment (including amplifiers).
8. This device should be connected to the socket by protective grounding. Do not use socket that fails to be grounded safely. If the supplied plug does not match your socket, consult a professional or an electrician about how to replace the old socket.
9. Protect the wires from being trampled on or squeezed, paying particular attention to the plugs, power outlets and where they leave the device.
 1. Unplug this device during lightning or when not in use for a long time.
11. Maintenance by qualified personnel, such as damaged power cord or plug, liquid or object splashing into the device, is mandatory. The equipment has been exposed to rain or moisture, does not work properly, or has fallen.
12. The input level of the amplifier should not exceed the nominal sensitivity value.
13. Do not connect the output of one channel of the amplifier to the input of another channel.
14. Do not use the output of an amplifier in parallel or in series to the output of another amplifier.
15. If the output signal is connected with more than three amplifiers, a signal allocator is recommended to ensure that the input signal is not distorted.
16. Do not place liquid-filled containers or exposed flames on top of the amplifier. For example, vases, candles, etc.
17. The power plug and power switch should keep convenient operation.
18. Symbolized: "⚡" terminals and external wires connected to them are dangerous live terminals.
19. All-pole power switches with distances of at least 3mm from each pole contact should be connected to the electrical facilities of the building.



The exclamation mark inside the equilateral triangle is a reminder to users of the important operation and maintenance (maintenance) instructions in this manual.



The lightning bolt beside the output of the amplifier warns the user of the risk of electric shock. Output connectors that are potentially dangerous are marked with lightning bolts. Do not touch the output terminal when the amplifier power is turned on. Switch off the amplifier before making all connections.



A lightning bolt with arrows inside an equilateral triangle warns the user that there is an uninsulated "dangerous" voltage inside the housing of the product, which can cause electric shock hazard to the human body.



Caution: To avoid the risk of electric shock, do not remove the housing. No user-serviceable parts inside. Contact qualified professionals for repair.



Warning: To avoid fire or shock, do not rain or damp the device.



It is recommended to use below 2000 m above sea level.

RADIATION CONDITIONS OF POWER AMPLIFIERS

Stacked Installation

To ensure the thermal environment, please install the product to meet the following conditions

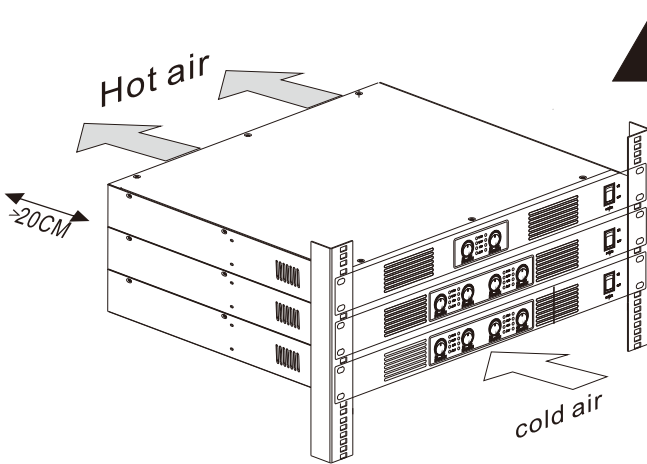

Before the completion of the project, because there is a lot of dust in the construction environment, a large amount of dust will accumulate in the filter during debugging, blocking the wind path, causing potential failure. If this happens, it is recommended to use a high-power vacuum cleaner to clean the filter directly, and to do maintenance once a month to ensure good heat dissipation. Input/output connector cables cannot be stacked on the product exhaust to block the air outlet.



The ambient temperature should be <35 C



When stacking non-horizontally, it is recommended to exhaust the air upwards or directly

AVOIDING WIND SHORT CIRCUIT

Prevent the exhausted hot air from returning to the front suction opening

Force hot air to be removed by installing a strong exhaust device

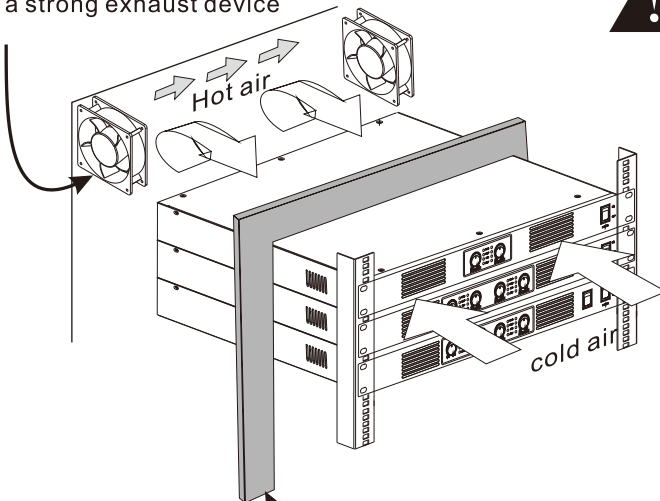

Verify that the temperature in the cabinet is under the limit condition and should be kept below 35 C during project debugging.



Block hot air back to the front suction opening

INSTRUCTIONS FOR FRONT PANEL USE

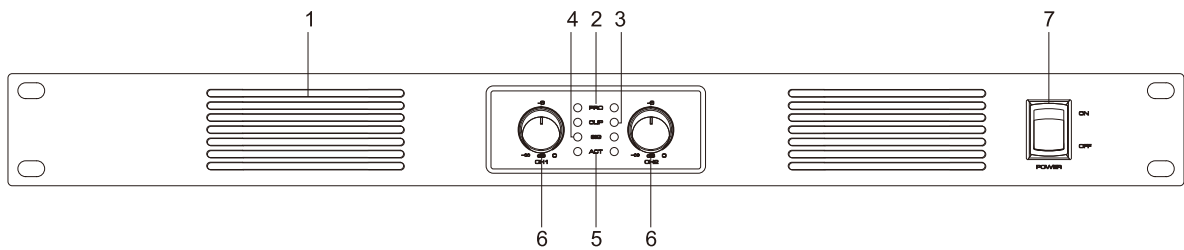

1. Cooling Hole

The high temperature inside mainly relies on the exchange of heat with the outside cold air through the heat sink to transfer heat in time. To prolong the life of the machine, do not block the cooling hole, the fan speed increases automatically when the load is high.

2. PRO

Lights up when any protective circuit operates.

3. CLIP

This LED flashes bright orange light when peak clipping occurs. The intensity and duration are related to the degree of peak clipping.

4. SIG

Signal level indicates that the brightness changes with the magnitude of the output signal.

5. ACT

This indicator lights up when the power amplifier starts to work.

6. A-channel volume control

B-channel volume control

7. Power switch

Press ("ON") to turn on,

Shut down when you press ("OFF").

INSTRUCTIONS FOR USE OF REAR PANEL

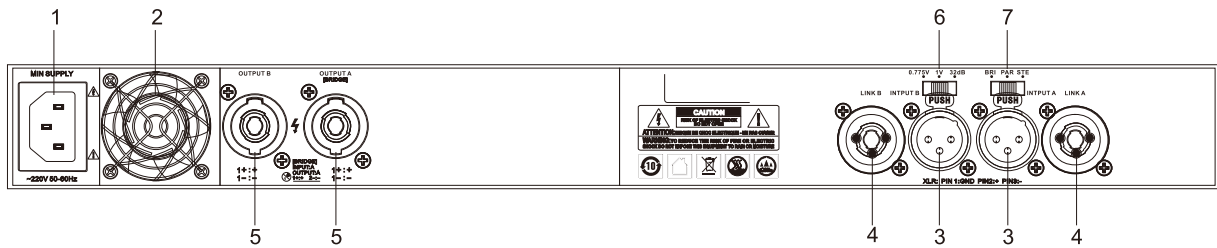

1. Power Input

The power supply voltage must match the nominal voltage of this unit.

2. Cooling Fan

The high temperature inside the cooling fan mainly relies on the exchange of heat with the outside cold air through the cooling holes. To prolong the life of the machine, do not block the cooling hole, the fan speed increases automatically when the load is high.

3. Balance Xlr Signal Input

Pin 2 positive, pin 3 negative, pin 1 shielded (grounded).

Used for long or short distance connections, fixed or frequently plugged in.

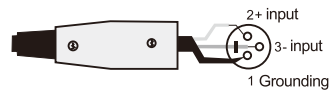

4. Link socket

1 Channel, 2 Channels, 3 Channels, 4 Channel Link Socket, Connect to another power amplifier with this balanced socket.

5. Speaker Output Jack

Speaker Output socket 1 channel, 2 channels, 3 channels, 4 channels connect this output to the speaker.

6. Sensitivity Selection Dial Switch

0.775V / 1V / 32dB

7. Operating Mode Selection Switch

Bridge/Parallel/Stereo

FUNCTIONAL DESCRIPTION OF REAR PANEL

Stereo Mode

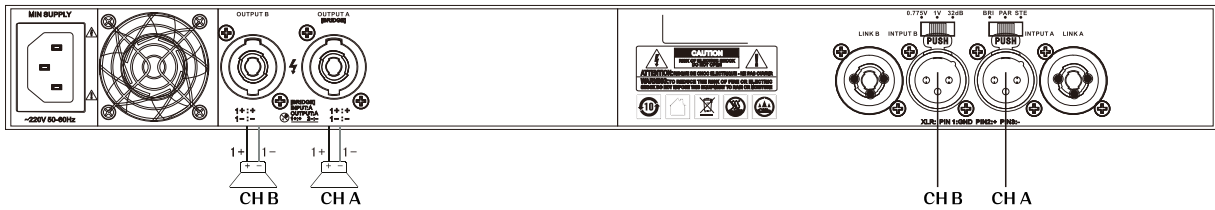

Before mode setting, make sure to turn off the amplifier and turn the mode switch (as shown in Figure 1) In stereo mode, channel A and channel B operate separately, and the signals input to channel A can only be output by channel A. Similarly, input to other channels can be analogous.

BRI PAR STE
(Figure 1) :

Parallel mode

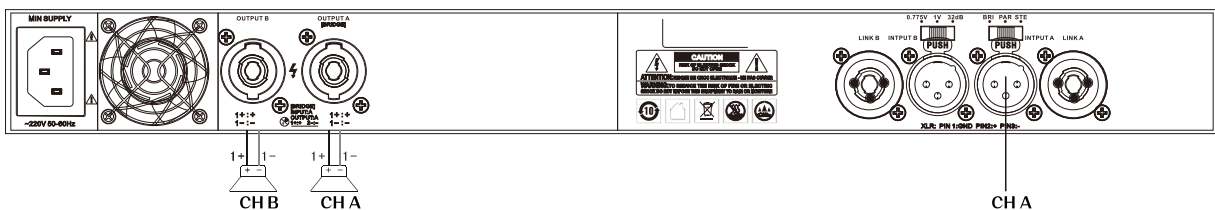

Make sure to turn off the amplifier and turn the mode switch (as shown in Figure 2) before setting the mode. Channel A and Channel B are connected side by side. In parallel mode, signals are input from Channel A and output from Channel A and B separately. Similarly, input to other channels can be analogous.

BRI PAR STE
(Figure 2) :

Bridge mode

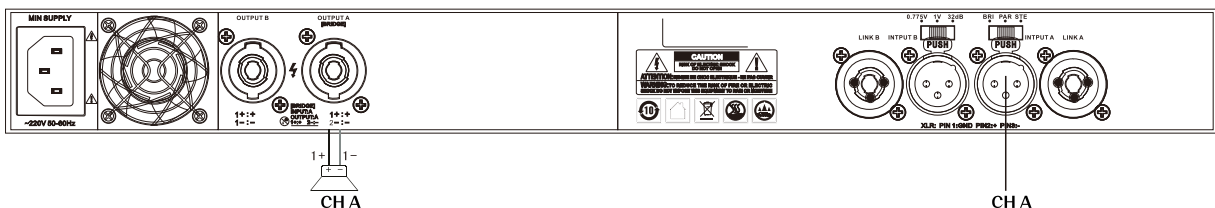

Before mode setting, make sure to turn off the amplifier and turn the mode switch (as shown in Figure 3) Channel A and Channel B are bridged. In bridging mode, signals are input from Channel A and output at the bridging terminal. Adjust the tone of channel A+B system synchronously only with the tone of channel A.

BRI PAR STE
(Figure 3) :

SPECIFICATIONS

* Measured with 20ms pulse 1kHz sine wave at 1% total harmonic distortion

** Measured with 10ms pulse 1kHz sine wave at 1% total harmonic distortion

CH	2CH
@8Ω Output Power / CH *	350W
@4Ω Output Power / CH **	525W
@8Ω Bridge Output Power **	1050W
Frequency Response (1W, 8Ω, ±1dB)	20Hz-20KHz
Total Harmonic Distortion (8Ω / 1kHz) 1/8Power	<0.1%
Conversion Rate	30V/us
Damping Coefficient1(Hz)	>500:1
Signal To Noise Ratio	110dB
Channel Separation	>75dB
Input Impedance	20KΩ Balanced input / 10KΩ Unbalanced Input
Input Gain Range	0.775V、1V、32dB
Net Weight	6.35kg
Gross Weight	7.55kg
Body Size	483mmX380mmX45mm
Package Size	535mmX500mmX90mm
Working Voltage	AC220V/50-60Hz

Specifications are subject to change without notice.



SHENZHEN S TRACK SCIENCE TECHNOLOGY CO., LTD

Web: www.s-track.com.cn

Tel: +86 755 29983191

Mail: service@s-track.cn

Add: 9F, 1B, Shangzhi Technology Park, Guangming District, Shenzhen City, Guangdong Province, China 518107